



Energy, Environment and Storage

Journal Homepage: www.enenstrg.com



Investigation of dust explosion in food silos: a review

Salih AÇIKGÖZ^{1*},

¹Erciyes University, Faculty of Engineering, Department of Mechanical Engineering, Kayseri, Turkey

mcsalo@hotmail.com ORCID:0009-0007-8351-3846

ABSTRACT. In this article, dust explosion phenomena and the status of research conducted on silos are reviewed. Dust explosions cause loss of life and property in many industrial facilities. There are many recorded dust explosion cases in our country as well as in the world. For example, in our country, in 2023, a dust explosion occurred in the TMO Kocaeli General Directorate (Derince Port Silo), in which 2 people died and great material damage occurred, as reflected in the national press. When we look at the various dust explosion cases that have occurred in the world, it is understood that they mostly occur in silos used for storage in the agricultural and food sectors. Licensed warehouses have been established in many regions of our country in order to store basic and processed agricultural products that can be standardized with the Agricultural Products Licensed Warehousing Law No. 5300, which came into force after being published in the Official Gazette on 17/02/2005, in safe and healthy conditions in warehouses belonging to licensed warehouse enterprise and continues to be established. It is important to understand the many factors affecting dust explosion, such as dust dispersion, properties, discharge, etc., and to design silos according to these factors. These effects are tried to be determined and understood through experimental or CFD simulations.

Keywords: Dust Explosion, Dust, Sizing, Silo, Computational Fluid Dynamics

Article History: Received:xxx; Revised: xxxx; Accepted:xxx; Availableonline: xxx (8 pt)

1. INTRODUCTION

1.1. Definition of Dust

There are various standards for dust definitions:

- In the TS EN 60079-10-2: 2015 standard, it is stated that dust includes flammable dust and flammable volatiles. Combustible dust is defined in the standard as finely divided solid particles with a nominal size of 500 μm or less, which can form explosive mixtures with air at atmospheric pressure and normal temperature. Flammable volatile is defined as a solid particle with a nominal size greater than 500 μm that can form an explosive mixture with air at atmospheric pressure and normal temperature [1].
- According to BS 2955: 1958 [2,3], substances with a grain size of less than 1000 μm are defined as 'powders', while when the particles are smaller than 76 μm in diameter they are called 'dust'.
- According to NFPA [4], "dust" is any finely divided solid with a diameter of 420 μm or less that, when suspended in air, presents a risk of fire or explosion on contact with an ignition source.

1.2. Dust explosion

An explosion begins with the rapid burning of flammable dust particles suspended in the air. The intensity and speed of the explosion depend on the grain fragmentation of any solid that can burn in air [4]. Depending on the small particle size, combustion can be more rapid and explosive up to a certain stage. If the burning dust particles are not in a closed area, a sudden fire will occur. However, if the burning dust particles are in a partially closed environment, the heat generated by the combustion, the spread of flame along the dust particles, and the formation of large amounts of heat and reaction products, can cause rapid pressure build-up. This can also cause an explosion. The intensity of the explosion depends on the degree of confinement in the enclosed space, depending on the particle size, as well as the amount of energy released due to heat losses. In some exceptional cases, even if the dust particles are not in the enclosed space, if the reactions due to combustion occur faster than the pressure can disperse at the edge of the cloud, a devastating explosion can occur [5].

1.3. Dust Explosion Pentagon

Like all fires, dust fires also occur as a result of the combination of a flammable material (dust) with an

*Corresponding author: mcsalo@hotmail.com

ignition source in the presence of oxygen. According to this explanation, if one of the three components in the fire triangle in Figure 1 is not present, a fire will not occur [6].

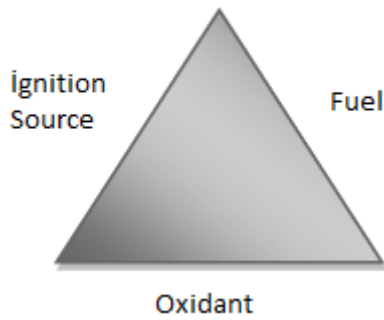

Figure 1. Fire triangle

Dust explosion requires two more components besides the three components in the fire triangle. These two components are; keeping the dust suspended and confining the dust cloud in a certain volume. By adding these two components to the fire triangle, the dust explosion pentagon in Figure 2 is formed [6].

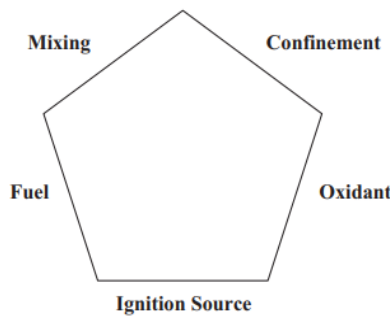

Figure 2. Dust explosion pentagon

Dust explosions have very high energy and can create pressure waves strong enough to destroy structures or harm people in the surrounding area. People exposed to dust explosions are usually harmed by burning due to the burning dust cloud or by flying pieces of equipment and collapsing walls caused by the explosion [7].

1.3. Domino Effect

Dust explosions occurring in a facility are divided into two classes as primary or secondary explosions. Primary dust explosions are explosions that occur as a result of the dust cloud coming into contact with any ignition source inside a piece of equipment such as a mixer, dryer, filter, elevator, pneumatic carrier, silo, etc., since the necessary dust concentrations for an explosion seldom gather outside the processing vessels [6,7]. This may cause the vessel to rupture if there is no adequate pressure relief device/ventilation or if the material resistance pressure is too low [6].

Secondary dust explosions are explosions that occur when dust accumulated nearby is lifted and ignited by the impact of a primary explosion (Figure 3) [4]. Although it is crucial to attempt to remove the chance of primary dust explosions happening, additionally it is crucial to stop the initial explosion from triggering a chain reaction that results in secondary explosions, as secondary dust

explosions are invariably more damaging than primary dust explosions [3,8,9].

Due to a dust explosion happening in one section of the conveying system, the pressure and/or flames might travel to other sections through the connecting pipes. For instance, experiments performed on an explosion in a vented bag filter with a reduced explosion pressure below 500 mbar have indicated that the explosion is likely to propagate to the inlet pipe. This potential for spreading could result in the explosion growing with increasing severity throughout the system[10]. Due to the turbulence effect, the flame traveling through the channel tends to speed up. This leads to a jet flame entering the second vessel. As a consequence, even the ventilation of the second vessel where the flame disperses cannot prevent high combustion rates under high pressures, and the amount of dust contained alone does not pose much of a danger [11].

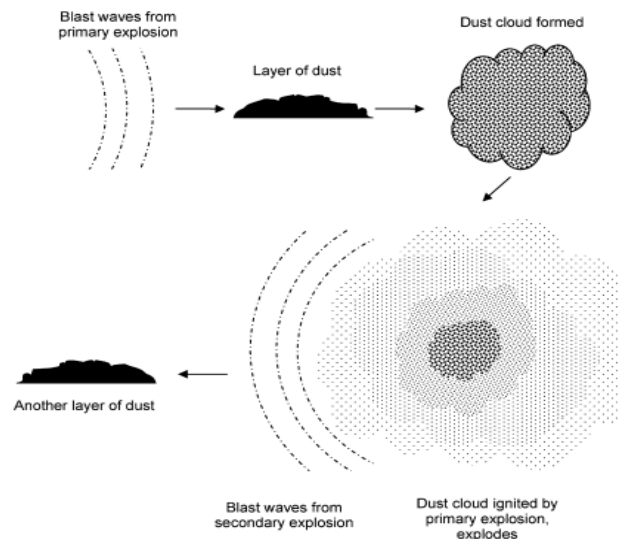

Figure 3. Chain reaction in dust explosion)

1.4. In-depth Case Reports On Several Major Dust Explosions

Indeed, a representative table is provided, listing dust explosions that are likely to occur daily in all industrialized countries [12].

According to dust explosion statistics, a large percentage of dust explosions occur in silos designed for storage in the agricultural and food industries [5].

In addition, not included in Table 1 the dust explosion that last occurred in our country in 2023 at the TMO Kocaeli General Directorate (Derince Port Silo) caused the death of 2 people and great material damage [27].

2. TYPES OF SILOS

Today, there are various bulk materials, the total number of which reaches several thousand. Concrete or metal welded silos are used to store these materials [28 – 37].

Table 1. Illustrative case examples of dust explosion occurrences (1911–2004)

Date	Location	Material	Plant/building	Dead/injured	Reference
	Turin, Italy	Wheat flour	Bakery	2i	[5]
1807	Leiden, The Netherlands	Black powder	Ship	151d/2000i	[14]
1911	Glasgow, UK	"	"	3d/8i	[13]
1911	Liverpool, UK	"	"	37d/100i	[13]
1911	Manchester, UK	"	"	3d/5i	[13]
1913	Manchester, UK	"	"	3d/5i	[13]
1916	Duluth, MN	Grain	Steel bin	-	[15]
1919	Cedar Rapids, IA	Corn starch	Starch plant	43d	[13]
1924	Peking, IL	Corn starch	Starch plant	42d	[13]
1924	USA	Sulphide dust	"	1d/6i	[13]
1924	USA	Sulphide dust	"	1d/1i	[13]
1924	USA	Sulphide dust	"	2d/1i	[13]
1926	USA	Sulphide dust	"	3d/1i	[13]
1930	Liverpool, UK	"	"	11d/32i	[13]
1944	Kansas City, KS	Grain dust	"	"	[13]
1949	Port Colbourne, CA	Grain	Steel bin	-	[15]
1952	Bound Brook, NJ	Phenolic resin dust	Hammer mill	5d/21i	[13]
1952	Saskatchewan	Grain dust	Shipping bin	6d/14i	[15]
1955	Waynesboro, GA	Grain dust	Feed plant	3d/13i	[13]
1956	South Chicago	Grain dust	Elevator	-	[15]
1958	Kansas City	Grain dust	Elevator	-	[15]
1960	Canada	Sulphide dust	"	2d/-	[13]
1960	Albem, Vienna	Grain dust	"	-	[15]
1962	St. Louis, MO	Grain dust	Feed plant	3d/13i	[13]
1964	Paisley, UK	"	"	2d/34i	[13]
1965	London, UK	Flour	Flour mill	4d/37i	[15]
1969	Sweden	Sulphide dust	"	2d/1i	[13]
1970	Kiel, FRG	Grain dust	Grain silo	6d/18i	[13]
1970	Germany	Grain dust	Silos on shipping canal	6d/17i, loss \$10 million	[15]
1970	Norway	Wheat grain dust	Silo	"	[5]
1971	New Orleans	Bushel	Elevator	"	[15]
1972	Norway	Silicon	Milling section	5d/4i	[5,16]
1973	Norway	Aluminum	Mixing vessel	5d/2i	[5]
1974	Canada	Sulphide dust	Fox mines	"	[13]
1974	Preska, South Africa	Sulphide dust	Mines	"	[13]
1975	Norway	Fish meal	Fish meal grinding plant	1d/1i	[5]
1976	Norway	Barley/oats dust	Silo	-	[5]
1976	Oslo, Norway	Malted barley dust	Silo	-	[5]
1977	Galvesto, TX	Grain dust	Grain silo	15d	[13]
1977	Westwego, Louisiana	Grain dust	Grain silo	36d/10i	[16]
1979	Lerida, Spain	Grain dust	Grain silo	7d	[13]
1979	Canada	Sulphide dust	Ruttan mines	"	[13]
1980	Germany	Coal	Cement factory	-	[5]
1980		Corn dust	Bucket elevator	-	[17]
1980		Corn dust	Cross tunnel, bucket elevators	13i	[17]
1980		Corn dust	Grain silo	8i	[13]
1980		Corn dust	Head house	Loss \$3,300,000	[13]
1980		Corn dust	Shipping bin	1d/4i, loss \$2,000,000	[17]
1981	Canada	Sulphide dust	Mattabi mines	"	[13,16]
1981	Corpus Christi, TX	Grain dust	Bucket elevator/Elevator	9d/30i	[17]
1981	Bellwood, NE, USA	Grain dust	Bucket elevator	Loss \$6,400,000	[13]
1981	Germany	Coal	ii dust burner plant, cement wc	-	[5]
1982	British Columbia, Canada	Coal	Silo	-	[5]
1983	Anglesey, UK	Aluminum	Aluminum powder production	2i	[5]
1984	USA	Coal	Silo	-	[5]
1985	Australia	Sulphide dust	Elura mines	"	[16]
1985	Canada	Sulphide dust	Lynn lake	"	[13]
1985	Germany	Coal	Silo	1i	[5]
1985	Norway	Rape seed flour pellets	Silo	-	[5]
1986	Canada	Sulphide dust	Brunswick mines	"	[13]
1986	Sweden	Sulphide dust	Langsele mines	"	[13]
1986	Canada	Sulphide dust	Dumugami mines	"	[13]
1986	Australia	Sulphide dust	Woodtown	"	[13]
1987	Canada	Sulphide dust	GECCO mines	"	[13]
1987	China	Textile dust	Dust collection system	58d/177i	[18,19]
1987	Oslo, Norway	Malted barley dust	Silo	-	[5]
1988	Norway	Wheat grain dust	Silo	-	[5]
1988	Sweden	Coal	Silo	-	[5]
1989	Sweden	Palletized wheat bran	Silo	-	[5]
1990	Japan	Benzoylperoxide	Storage	9d/17i	[20]
1992	Moriya, Japan	Potassium chlorate and aluminum dust	Mixing operation	3d/58i	[20]
1994	Okaharu, Japan	Cotton waste	Textile mill	"	[13]
1994	Tokyo, Japan	Rubber waste	Shoe factory	5d/22i	[13]
1997	Japan	Tantalum dust	"	1d/1i	[22]
1997	Blaye, France	Grain	Storage	11d	[21]
1999	Michigan	Coal dust (cause for secondary explosion)	Powerhouse	6d/14i	[23]
1999	Massachusetts	Resin	Oven	3d/12i	[24]
2000	Japan	Mg-Al alloy	"	d/1i	[13]
2000	Modesto California	Aluminum dust	"	"	[16]
2002	Mississippi	Rubber	Recycling plant	5d/1	[25]
2003	Kentucky	Resin	Production line	7d	[26]
2003	Kinston, NC	Polyethylene	Pharmaceutical plant	6d/38i	[26]
2004	Avon, OH	Lacquer dust	"	"	[16]

^a Details not available.

2.1. Metal Silos

Metal silos are closed cylindrical structures made of airtight galvanized iron sheet. Metal silo technology is effective against insect and rodent damage and effectively protects the harvested grains (SDC, 2008a; FAO, 2008; CIMMYT, 2009a,b). Since the metal silo is not airtight thanks to its insulation, it eliminates the oxygen inside. As a result, it causes the possible harmful insects to die. It also entirely removes any pests or pathogens that might infest the grains inside. It allows the grains to be stored for a long time. Metal silos usually have a carrying capacity between 100 and 3000 kg (SDC, 2008a; FAO, 2008; CIMMYT, 2009a,b) [38].

Crop storage effectiveness is influenced by the duration of storage, the volume of storage, and losses (including quality deterioration) that occur during storage.) [39]. Metal silos can be used in different sizes depending on the need.

Metal silo, a technology used in many countries, provides the following key benefits:

- i. It ensures that products are stored in high quality for a long time,
- ii. It does not leave any residue in the fumigation that is effective in combating pests and it is airtight,
- iii. It significantly reduces the use of pesticides,
- iv. They take up little space depending on their location,
- v. It significantly reduces post-harvest losses,
- vi. It allows small-volume producers to benefit from fluctuating market prices,
- vii. It keeps away rodents and other pests that could jeopardize consumer health if consumed,
- viii. It can be constructed with local workmanship and materials (FAO, 2008) [38].

2.2. Metal Silo Types

Metal silo types are shown in Figure 4. Today, silos are stored by filling them with bulk materials carried by horizontal transport systems (chain, belt or helical conveyors) and elevators, which are vertical transport systems, under the control of SCADA and PLC (Programmable Logic Controller).

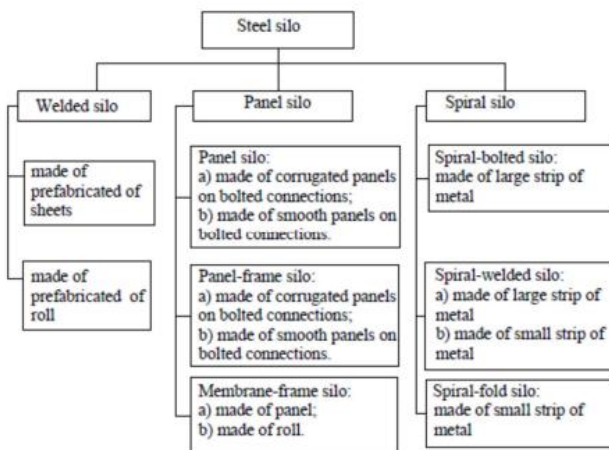

Figure 4. Classification of metal silos

If we talk about it in this section the PLC (Programmable Logic Controller) and SCADA (Supervisory Control and Data Acquisition) system used as an automatic system for control and monitoring of grain storage [40, 41].

The main variable that is essential for proper storage of grains is the input variables that will be controlled using PLC. After the SCADA system obtains the necessary information and monitors the general situation, all operational functions (various grain processing equipment such as transportation, cleaning, weighing, ventilation, etc.) are performed by the SCADA user's operating and monitoring interface [42, 43].

PLC is a digital computer that performs control logic, sequencing, timing, arithmetic data processing and counting functions. PLC is designed to withstand multiple environments and temperature etc. Processor (CPU) is the brain of PLC. It has microprocessors to provide logic and control communication between modules. The memories record the results of the logical operations performed by the processor. The IO section consists of input and output modules. This system forms the interface through which the plant devices are connected to the controller [44, 45]. The programming device enters the desired program into the processor's memory. The power supply provides 24 V DC power to the modules. Ladder logic is a programming language primarily used to develop software for PLCs. It conveys a program using a graphical diagram that reflects the circuit diagrams of relay logic hardware [46, 47].

The term SCADA (Supervisory Control and Data Acquisition) generally denotes centralized systems that oversee and manage entire facilities or networks of systems distributed across extensive areas. A Human-Machine Interface (HMI) is a system that shows duration data to an operator, allowing the operator to manage and control the duration. The HMI is frequently linked to the databases and software applications of the SCADA system to access data required for current maintenance, logistical details, and management information, including comprehensive schematics for specific sensors or machines and troubleshooting guides from expert systems (Figure 5) [48].

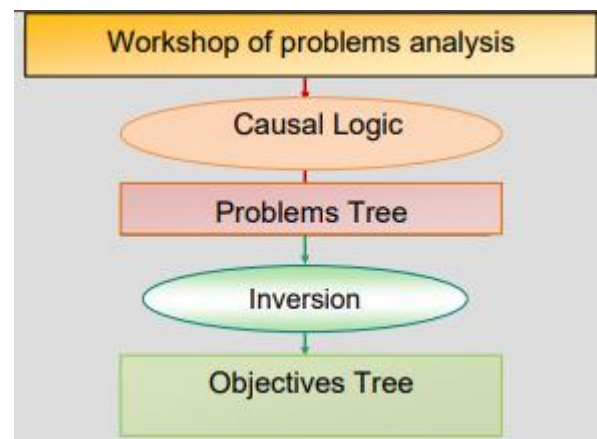

Figure 5. OOPP method

Silos are usually either on the ground with a flat base or elevated with a conical base with a steel construction

(Figure 6) [49,50]. The opportunity to extract the stored product by gravity feeding makes the conical base very attractive (Figure 6b), but it has disadvantages such as the height of the structure, the reduced storage capacity, the high energy required to transport the stored product to the storage, the damage to the particles due to the fall of the stored product from a height and the complexity of the structural design. Flat-based silos are lightweight structures, but they are more affected by the wind when empty and are more sensitive to asymmetry during storage [50]. The primary structural components of the silo are the roof, the enclosure and the base. The general appearance of flat and conical-based silos is shown in Figure 6 [49].

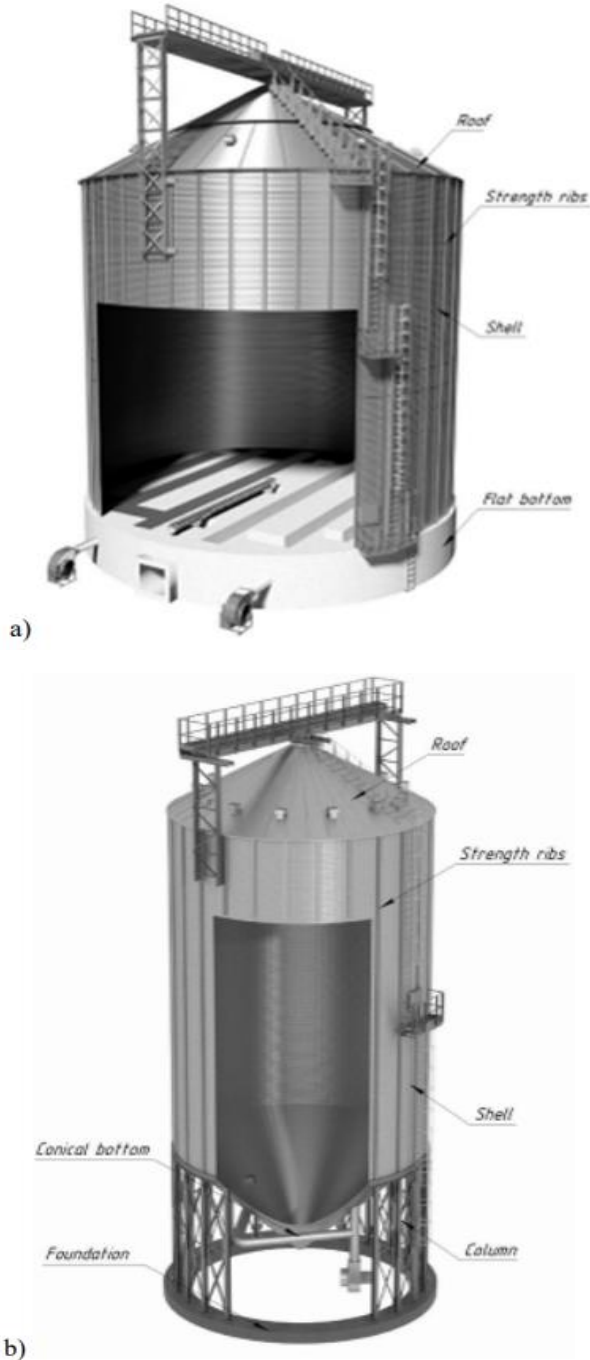

Figure 6. Elevated (conical bottom) and above ground (flat bottom) silos: a) above ground (flat bottom silo), b) elevated (conical bottom silo) [49]

2.2.a. Welded Silos

Welded silos are made of cylindrical metal sheets welded together as seen in Figures 6a and 6b. They are divided into two types according to the manufacturing method: prefabricated and roll sheet. Sheet metal silos are made of separate metal sheets welded to a single enclosure. Roll silos made of a single roll with a height that matches the height of the cylinder. In the course of installation, the roll is opened vertically around the foundation to create a complete silo wall. The most well-known benefits of these silos are their tightness and durability [49].

2.2.b. Panel Silos

As seen in Figure 7c, panel silos are cylindrical structures composed of corrugated or flat sheets that are joined together with bolts. The corrugated panel profile, which provides more resistance against the lateral load of the silo, contributes to metal savings. In industrial silos, supports are created with strength bars to offset the reduction in the panel's load-bearing capacity due to the corrugated profile. The advantages of prefabricated silos are resistance to large radial loads, lack of welding, and high strength. The disadvantage of these silos is the extensive number of bolted flange joints [49]. This form of silo is widely used in both the private and public sectors in our country.

Panel frame silos (Figure 7d), a type of panel silo, have bent profile panels connected by bolts. Gasketed washers are mounted under the bolt heads to seal the silo. The silo has a conical roof and consists of ring-shaped and radial slats on which the flooring is placed. In addition to its advantages such as the absence of welded joints and its durability, it has disadvantages such as the many bolted joints, leakage, excessive metal usage and elevated labor expenses) [49].

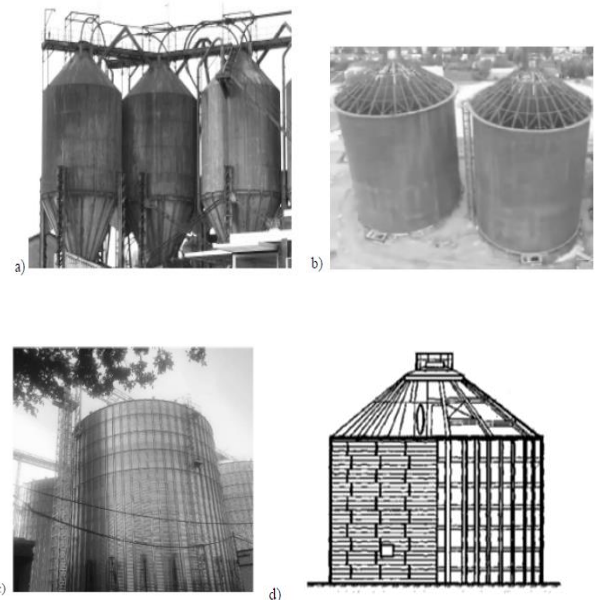

Figure 7. Different types of metal silos: a, b) welded silos; c) panel type; d) panel frame type) [49]

Membrane frame silos were engineered at a research facility in Moscow [51]. The major structural part of these silos, the membrane, is in the shape of a cylinder, made

of tape with a thickness of 0.6-1 mm and a width of 1250 mm. This silo option has disadvantages such as excessive material consumption and complicated installation, but it allows full use of the calculated resistance due to the fact that only the membrane, which takes the tensile force, is covered [49].

2.2.c. Spiral Silos

Spiral bolted silos (Figure 8a) are cylindrical structures made of spirally curved metal strips, the edges of which are connected by bolts at certain intervals with a corner or channel lath. In addition to their advantages such as high strength, their connections are not welded, the roll gap edge does not require additional processing and there are no molded edges for height. Despite their advantages, the need for special and additional equipment for the formation of the enclosure and assembly, the numerous drilling operations for the bolt assembly slots and the assembly of additional vertical beams for wall strength are disadvantages [49].

Spiral welded silo (Figure 8b) is a cylindrical silo made of a spiral curved metallic strip with welded edges. The rolled geometric billet thickness is 1 – 4 mm, while the width is 300 – 1250 mm. The disadvantage is that a lot of welding is done in the silo field and the edges need to be processed additionally. In addition to the advantage of impermeability, another advantage is its durability [49].

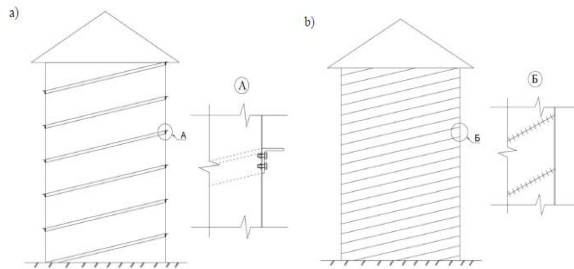

Figure 8. Spiral silo variations: a) spiral bolted; b) spiral welded [49]

Spiral folded silos (Figure 9) are cylindrical structures consisting of a spiral connection by double folding of steel strip. This silo, which was first built in Germany in 1969, was conceived in 1968 by German researcher Xavier Lipp, who processed metal sheets using special equipment (Figure 9) [52]. Some of its advantages are short installation time, low number of assemblers required, low maintenance, earthquake resistance, low cost, long life, and leak-proofness. Its disadvantages include the fact that the silo volume does not exceed 10 thousand m³ and additional costs such as transportation of assembly equipment to the silo installation site [49].



Figure 9. Spiral -fold silos: Xavier Lipp's first spiral-fold silo, 1969[49].

3. CATEGORIZATION OF DUSTS

A coating of dust is considered 'flammable' if it can be set off by a source of ignition and the resulting fire in the area can continue to spread significantly once the ignition source is gone) [10].

According to the composition of the dust, information on whether it is explosive can be obtained by referring to the list of dusts tested experimentally and published by HM Factory Inspectorate, UK Department of Employment. This classification applies to dusts at or around 25 °C (ambient temperature) at the time of ignition [53].

The combustion class is an additional indicator of a dust layer's ignitability and burning intensity [54,55]. This categorization is based on the way a defined pile behaves when subjected to a gas flame or a hot platinum wire as the ignition source):

- CC1: no ignition; no spontaneous combustion.
- CC2: short-term ignition and quick extinguishing; short-term local combustion.
- CC3: localized burning or flash without propagation; local continuous combustion without spreading.
- CC4: spread of a glowing fire; burning to spread.
- CC5: propagation of an open flame; expanding open flame.
- CC6: explosive combustion; violent burning.

A third type of dust classification is determined by the " K_{St} value". The " K_{St} value" expresses the highest pressure rate increase when a dust in a 1 m³ container ignites. In other words, it is the intensity of the dust explosion [56]. The K_{St} concept was defined by Bartknecht [57,58], who based it on the so-called cube root law, as follows:

$$\left(\frac{dP}{dt}\right)_{max} V^{1/3} = constant \equiv K_{St} \quad (1)$$

In the International Standards Organization (ISO), the K_{St} (bar m/s) value, numerically defined by $(dP/dt)_{max}$ (bar/s) in 1 m³ standard test [59], is expressed as a 'specific dust constant'.

The abbreviation 'St' is derived from the German word staub, meaning dust.

Explosivity is ranked according to K_{St} as follows:

K_{St}	= Group St0: Non-explosible	Increasing Explosivity ↓
$0 < K_{St} < 200$	= Group St1 weak	
$200 < K_{St} < 300$	= Group St2 strong	
$300 < K_{St}$	= Group St3 very strong	

Finally, an explosivity index was developed by The Bureau of Mines that ranks dusts against Pittsburgh coal. The explosivity index (IE) developed is equal to the outcome of the explosion intensity (ES) and the ignition susceptibility:

$$IE = IS \times ES \quad (2)$$

$$IS = \frac{(MIT \times MIE \times MEC)_{P_c}}{(MIT \times MIE \times MEC)_{sample}} \quad (3)$$

$$ES = \frac{(MEP \times MRPR)_{P_c}}{(MEP \times MRPR)_{sample}} \quad (4)$$

In the equations, MEC represents the lowest explosive concentration, MEP denotes the highest explosion pressure, MIE refers to the minimum energy required for ignition, MIT stands for the minimum temperature needed to ignite and MRPR stands for the maximum rate of pressure rise. The subnotations P_c and sample refer to the Pittsburgh coal and sample. This explosivity index is a comparative measure. Therefore, less influenced by the equipment used, although determining it necessitates performing a complete series of tests) [3,8].

4. SOME STUDIES ON DUST EXPLOSION

Alberto Tascón et al. simulated dust explosions in a 16.3 m³ vented silo utilizing a business CFD (computational fluid dynamics) software (Figure 10). The model used is a cylindrical steel silo with a steel silo with a cylindrical shape and a conical base and concentric chambers, built and equipped in the external experimental zones of the ETSIA School of Agricultural Engineering (Escuela Técnica Superior de Ingenieros Agrónomos) at the Polytechnic University of Madrid. The silos built for these experiments are made of steel and there are three of them, each possessing a distinct chamber non-concentricity. These silos were formerly employed to gauge the pressure applied by the materials contained within [60]. Corn starch values were taken as reference in the simulations.

In their simulations, a silo roof acting as a non-inertial ventilation panel and an inertial ventilation device were modeled. Various parameters that have an effect on the pressures generated by the explosion were investigated, including the properties of the beginning dust cloud, the dimension and place of the dust cloud, and the ignition position. Additionally, various sizes of ventilation areas

and activation pressures were considered. The obtained data were reported to be in agreement with explosion venting standards. The findings reveal that the negative pressures created can be of equal magnitude to the overpressures. For the inertial ventilation roof, the pressures and the associated ventilation areas were shown to be in accordance with NFPA 68 [61].

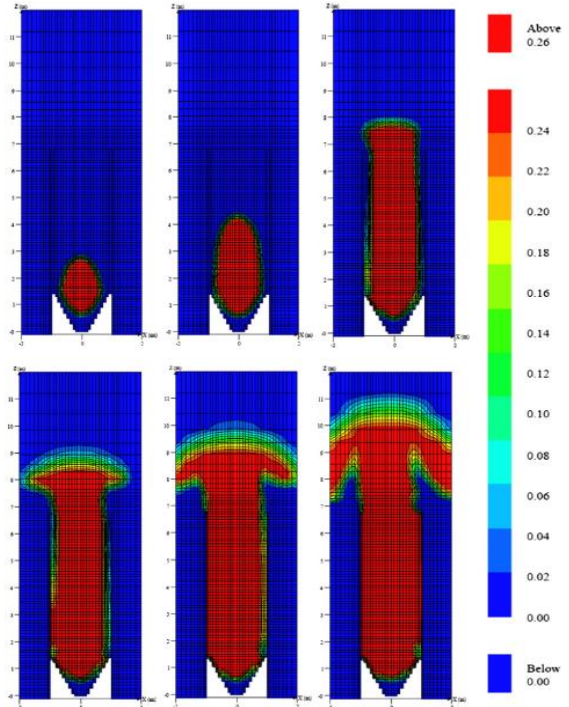

Figure 10. Simulated flame progression. Contours show the mass fraction of the combustion product (kg/kg). Six time intervals are depicted: 0.384 s, 0.428 s, 0.505 s, 0.520 s, 0.531 s, and 0.550 s. Condition set 1. A=2.84 m². P_{stat}= 0.03 bar (3 kPa).) [61]

C.Murillo et al. studied to characterize the behavior of transient gas-solid flow in a revised Hartmann tube (Figure 11) or related devices. They performed experimental research to assess the parameters affecting the typical properties of flammable solids. For the analysis, the evolution of dust clouds composed of various solid materials within the tube was assessed using fast-motion videos and particle dimension evaluations. They observed that two-phase flow caused changes in the particle dimension spread and separation levels determined during the dispersion process [62].

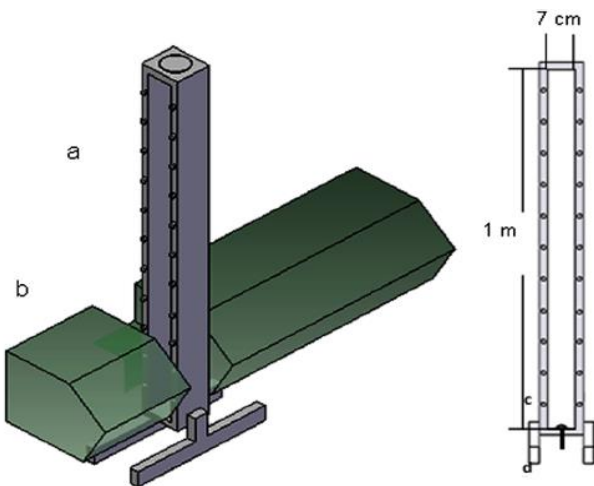

Figure 11. Experimental apparatus designed for analyzing solid material dispersion. a) Dispersion Tube, b) Particle dimension spread analyzer, c) Dispersion Nozzle, d) Gas Inlet) [62].

By modeling the conditions within the aforementioned special test equipment with the CFD (computational fluid dynamics) program ANSYS FLUENT® (Figure 12), an improved analysis was carried out at micrometric and submicrometric scales in order to evaluate the phase behavior of micrometric aluminum particles, which are dispersed flammable solids in air. Then they compared the data obtained with the CFD model. A computational fluid dynamics (CFD) simulation utilizing the Euler-Lagrangian approach was created using the ANSYS FLUENT program. They aimed to evaluate the flow characteristics related to the clustering and breaking of dispersed particles. Experimental data were used to accurately determine the changes in particle size distributions and to adapt a shattering model using CFD simulation. According to the results achieved from the simulation and experimental trials, the flow behavior of the aluminum powder dispersion in the first stages in the revised Hartmann tube was determined to be in the form of a flat profile. They found that the dispersion of the solid form and the progression of the internal gas flux are significantly affected by the change in the shape of the flow field and the air injection. They recommended the positioning of ignition sources 10 cm above the nozzle according to the mixture homogeneity due to the separation between the aluminum powders. They recommended a minimum ignition delay of 50 to 60 ms (minimum ignition lag of 50 to 60 ms) depending on the phase separation levels and the average diameter of the analyzed sample) [62].

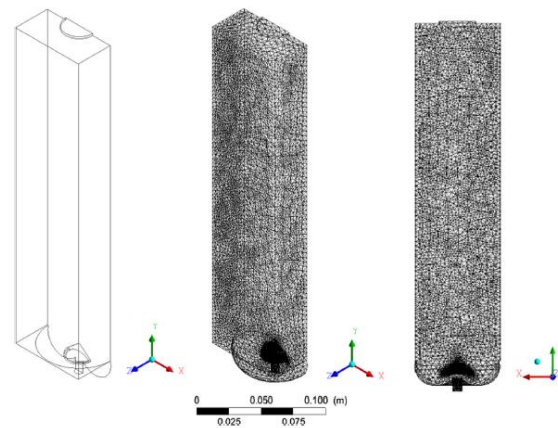

Figure 12. Overview of the flow field. a) Gas Injection, b) Dispersion Nozzle, c) Outlet) [62].

4. CONCLUSIONS

As it is known, different types of products are stored in silos. During storage, explosions can occur as a result of dust spreading and coming into contact with the ignition source. The pressure created by the explosions can cause material damage and even death [6]. In order to overcome the engineering challenges encountered in silo design and dust explosion protection, it is important to understand the characteristics and spreading movement of the dust and to determine the maximum pressure that can occur with an explosion. In addition to experimental studies, studies are also carried out on the aforementioned issues with the computational fluid dynamics method. It is important to examine the effects of diverse variables on the explosion ventilation in silos, encompassing the properties of the beginning dust cloud, the size of the dust cloud, its location, ignition point, the shape of the enclosed area, and the size of the ventilation.

In addition to preventing factors that may cause explosions in grain silos, studies will have a significant role in preventing the spread of flame and pressure when an explosion occurs, ensuring that the building material is manufactured from materials or designed to be resistant to the pressure and flame that will occur, and also determining the locations of silos, which are complex structures, that are prone to explosion in all precautions.

By determining the location where dust formation occurs and in which area of the transport units the explosion density is reached while the product is being transported during the filling or emptying of silos, the dust can be efficiently evacuated from the transport units through dust collection units. In addition, measures can be taken to avoid the dispersion of pressure and flame in order to prevent secondary explosions.

In a grain silo, there are various transport units as well as dust collection units, silo scales, volumetric scales, silos, filling bunkers, etc. All units operate as a whole under PLC and SCADA control. The transport techniques and design forms of the units can be redesigned to reduce the severity of the explosion.

In grain silos, products such as wheat, barley, triticale, corn, rye, oats, etc. are stored. Storage and unloading operations are carried out using common transport lines. For this reason, there are dusts of these products in silos and other units. The studies to be carried out will be a source of generating ideas in silo design according to the pressure or flame situations that could happen by considering the characteristics of the attributes of the dusts of the products to be stored.

In our world with a population of approximately 8 billion people, where food safety has also gained importance due to the significant impact of global climate change, scientific studies are aimed to minimize the material damage, negative effects on human health and loss of life, and possible accidents that may occur as a result of explosions in silos built with great effort and cost, even if they cannot be prevented.

It is important to be able to predict how explosive dusts spread in facilities, what the density, location and sources that can cause explosions are, and the pressures that can occur as a result of explosions through future studies. As a result of the studies to be carried out on the aforementioned issues, it will contribute to the development of issues such as the design of systems that will safely discharge the pressure that will occur due to explosions and the development of new units based on material strength, thus preventing explosions, preventing material accidents, and providing longer-term healthier product storage in grain warehouses.

REFERENCES

- [1] Turkish Standards Institute, TS EN 60079-10-2:2015 Explosive Atmospheres - Part 10-2: *Classification of Hazardous Areas - Combustible Dust Atmospheres Standard*.
- [2] BS2955: 1958, *Glossary of Terms Relating to Powders*, No. 505, British Standard Institute, London, 1958.
- [3] F.P. Lees, *Lees' Loss Prevention in the Process Industries* (Partially updated by S. Mannan), vols. 1–3, Elsevier/Butterworth-Heinemann, Oxford, 2005.
- [4] NFPA 68, *Guide for Venting of Deflagrations*, National Fire Protection Association, 2002.
- [5] R.K. Eckhoff, *Dust Explosions in the Process Industries*, 3rd ed. Gulf Professional Publishing, USA, 2003.
- [6] Tasneem A., Abbasi S.A., *Dust explosions—Cases, causes, consequences, and control*, Elsevier, Sayfa: 7-44, 2006.
- [7] U.S. Chemical Safety Board (CSB), *Investigation Report Combustible Dust Hazard Study*, Sayfa:0-0, 2006
- [8] F.P. Lees, *Loss Prevention in the Process Industries—Hazard Identification, Assessment and Control*, vol. 2, Butterworth Heinemann, London, 1996.
- [9] R.D. Pickup, *Dust explosion case study: 'Bad things can still happen to good companies'*, *Process Safety Prog.* 20 (2001) 169–172.
- [10] R. Siwek, *Determination of technical safety indices and factors influencing hazard evaluation of dusts*, *J. Loss Prevent. Process Ind.* 9 (1996) 21–31.
- [11] P. Kosinski, A.C. Hoffmann, *Dust explosions in connected vessels: mathematical modelling*, *Powder Technol.* 155 (2005) 108–116.
- [12] C. Proust, *A few fundamental aspects about ignition and flame propagation in dust clouds*, *J. Loss Prevent. Process Ind.* 19 (2005) 104–120.
- [13] G. Vijayaraghavan, *Impact assessment, modelling, and control of dust explosions in chemical process industries*, MTech Thesis, Department of Chemical Engineering, Coimbatore Institute of Technology, 2004.
- [14] H.J. Reitsma, *The explosion of a ship, loaded with black powder, in Leiden in 1807*, *Int. J. Impact Eng.* 25 (2001) 507–514.
- [15] O.F. Theimer, *Cause and prevention of dust explosions in grain elevators and flour mills*, *Powder Technol.* 8 (1973) 137–147.
- [16] S.K. Kuriechan, *Causes and impacts of accidents in chemical process industries and a study of the consequence analysis software*, MPhil Thesis, Pondicherry University, 2005.
- [17] C.W. Kauffman, R.F. Hubbard, *An Investigation of Fourteen Grain Elevator Explosions Occurring between January 1979 and April 1981*, Occupational Safety and Health Administration, Washington, DC, 1984.
- [18] X. Bowen, *The explosion accident in the Harbin Linen textile plant*, *EuropEx Newsl.* (6) (1988).
- [19] Z. Hailin, *Investigation of the dust explosion in Harbin linen factory*, Unpublished English manuscript, 1988 (cited in [5]).
- [20] Failure Knowledge Database, Japan Science and Technology Agency, <http://shippai.jst.go.jp/en/Detail?Ffn=0&id=CC1200059&>.
- [21] J. Barton (Ed.), *Dust Explosion Prevention and Protection: A Practical Guide*, Institution of Chemical Engineers (IChemE), Warwickshire, 2002.
- [22] National Institute of Occupational Safety and Health, Japan, www.anken.go.jp/english/kenkyu/houkoku/tr_99_03.html.
- [23] MIOSHA News, vol. 3, no. 3, OSHA, Michigan, 1999.
- [24] R. Zalosh, *A tale of two explosion*, in: *Proceedings of the 34th Annual Loss Prevention Symposium*, American Institute of Chemical Engineers, New York, 2000.
- [25] OSHA press release on Rouse Polymerics investigation, 2000, http://www.osha.gov/pls/oshaweb/owadisp.show_document?p_table=NEW_RELEASES&p_id=9830 (cited in [26])

- [26] W.L. Frank, Dust explosion prevention and the critical importance of housekeeping, *Process Safety Prog.* 23 (2004) 175–184.
- [27] <https://www.ntv.com.tr/turkiye/silolarda-yasanan-patlamada-tmo-ile-taseron-firma-yetkilileri-asli-kusurlu-bulundu,ZKaxIr4520CLQM90MStfGA>.
- [28] Brown, C.J. & Nielsen, J. (Ed.). 2011). *Silos: Fundamentals of Theory, Behaviour*. London and New York: E & FN Spon.
- [29] Rotter, J.M. (2001). *Guide for the Economic Design of Circular Metal Silos*. CRC Press.
- [30] Elliott, M.D, Teh, L.H.Ahmed, A. (2019). *Behaviour and strength of bolted connections failing in shear*. *Journal of Constructional Steel Research*, 153, 320-329. <https://doi.org/10.1016/j.jcsr.2018.10.029>
- [31] McCalmont, J.R. (1939). *Silo types and construction*. Washington: U.S. Dept. of Agriculture.
- [32] Thomson, F.M. (1997). *Storage and Flow of Particulate Solids*.
- [33] Sielamowicz, I., Balevicius, R. (2013). *Experimental and computation analysis of granular material flow in model silos*. Institute of Fundamental Technological Research Polish Academy of Sciences Experimental, Warsaw.
- [34] Schulze, D. (2009). *Powders and Bulk Solids*. Behavior, Characterization, Storage and Flow. Springer.
- [35] Demidov, S.V., Fisenko, A.S., Myslin, V.A. et al. (1984). *Architectural design of industrial enterprises*. Moscow, Stroyizdat.
- [36] Rosenblit, G.L. (1953). *Steel structures of buildings and structures of the coal industry*. Moscow: Ugletekhizdat.
- [37] Razumov, K.A., Petrov, V.A. (1982). *Design of processing plants*. Moscow, Nedra.
- [38] T. Tefera, F. Kanampiu, H. D.Groote, J. Hellin, S. Mugo, S. Kimenju, Y. Beyene, P. M. Boddupalli, B. Shiferaw, M. Banziger (2010). *Review The metal silo: An effective grain storage technology for reducing post-harvest insect and pathogen losses in maize while improving smallholder farmers' food security in developing countries*. Nairobi, Kenya. [doi:10.1016/j.cropro.2010.11.015](https://doi.org/10.1016/j.cropro.2010.11.015).
- [39] Thamaga-Chitja, J.M., Hendriks, S.L., Ortmann, G.F., Green, M., 2004. *Impact of maize storage on rural household food security in Northern Kwazulu-Natal*. *Tydskrif vir Gesinsekologie en Verbruikerswetenskappe* 32, 8-15.
- [40] Glaa, R., Lakhoua, M.N., El Amraoui, L., Using SART method and SCADA for the analysis and the supervision of a hydrogen circuit, *Journal of Electrical Engineering*, vol. 16, no. 3, 2016.
- [41] Lakhoua, M.N., SCADA application of a water steam cycle of a thermal power plant, ICMSAO 2013, IEEE, Hammamet, April 28-30, 2013.
- [42] Zhang, C., Zhou, X., Shi, Z., A novel method for measuring the moisture distribution of grain in the silo based on microwave image technology, *International Conference on Advanced Mechatronic Systems (ICAMEchS)*, 2017, p. 157-162.
- [43] Vogt, M., Gerding, M., Silo and tank vision: applications, challenges, and technical solutions for radar measurement of liquids and bulk solids in silos, vol. 18, *IEEE Microwave Magazine*, 2017.
- [44] Gergely, E.I., Coroiu L, Silaghi H., Dependability analysis of PLC I/O systems used in critical industrial applications, *Studies in Computational Intelligence*, vol. 417, 2013, p. 201 - 217.
- [45] Sheng, Z., Cuicui, J., Hua, S., Application of Siemens PLC and WinCC in the monitoring-control system of bulk grain silo, *Chinese Control and Decision Conference (CCDC)*, 2018, p. 4689 - 4693.
- [46] Yigit, E., İsiker, H., Toktas, A., Tjuatja, S., CS-based radar measurement of silos level, *IEEE International Geoscience and Remote Sensing Symposium (IGARSS)*, 2015, p. 3746 - 3749.
- [47] Karoui, M.F., Alla, H., Chatti, A., *Monitoring of dynamic processes by rectangular hybrid automata, Nonlinear Analysis: Hybrid Systems*, 2010.
- [48] Lakhoua, M.N., Review on SCADA Cyber security for critical infrastructures, *Journal of Computer Science and Control Systems*, vol. 10, no. 1, 2017.
- [49] S. Pichugin, K. Oksenenko. *Comparative Analysis Of Design Solutions Of Metal Silos*. Academic Journal. Series: Industrial Machine Building, Civil Engineering. – 2 (53)2019. <https://doi.org/10.26906/znp.2019.53.1890>.
- [50] J. M. Rotter. *Metal silos*. University of Edinburgh, UK. *Progress in Structural Engineering and Materials* 1998 Vol I(4): 428-435.
- [51] Kiselev, B.E. (1988). *Cylindrical spiral-wound capacity of the membrane-frame type. Design and construction of agricultural facilities*. Ser.: Building materials and structures, buildings and structures, 1, 29-30.
- [52] Xaver Lipp. Retrieved from <https://xaver-lipp.com/>
- [53] P.R. Amyotte, A. Basu, F.I. Khan, *Dust explosion hazard of pulverized fuel carry-over*, *J. Hazard. Mater.* 122 (2005) 23–30.
- [54] ISSA, *Determination of the Combustion and Explosion Characteristics of Dusts*, International Social Security Agency, Mannheim, 1998.
- [55] J. Gummer, G.A. Lunn, *Ignitions of explosive dust clouds by smouldering and flaming agglomerates*, *J. Loss Prevent. Process Ind.* 16 (2003) 27–32.
- [56] R.K. Eckhoff, *Partial inerting—an additional degree of freedom in dust explosion protection*, *J. Loss Prevent. Process Ind.* 17 (2004) 187–193.
- [57] W.Bartknecht, *Brenngas-undStaubexplosionen, ForschungsberichtF45*. Koblenz Bundesinstitut fur

Arbeitsschutz, Federal Republic of Germany,1978 (cited in [2]).

[58] W. Bartknecht, *Explosionen, Ablauf und Schutzmassnahmen*, Springer-Verlag, Berlin, 1981 (cited in [2]).

[59] *International Standards Organization, Explosion Protection Systems*. Part 1. Determination of Explosion Indices of Combustible Dusts in Air, ISO 6184/1, ISO, Geneva, 1985.

[60] A. Ramírez, J. Nielsen, F. Ayuga, *Pressure measurements in steel silos with eccentric hoppers*, Powder Technol. 201 (2010) 7–20.

[61] A. Tascón, P. J. Aguadob, *CFD simulations to study parameters affecting dust explosion venting in silos*, Powder Technology 272 (2015) 132–141.
<http://dx.doi.org/10.1016/j.powtec.2014.11.031>

[62] C. Murillo,O.Dufaud, N. Bardin-Monnier, O. López, F. Munoz, L. Perrin, *Dust explosions: CFD modeling as a tool to characterize the relevant parameters of the dust dispersion*, Chemical Engineering Science 104 (2013)103–116.

<http://dx.doi.org/10.1016/j.ces.2013.07.029>